

EXTERNAL CAPACITOR TABLE

	(')	(')

TYPICAL CHARACTERISTICS

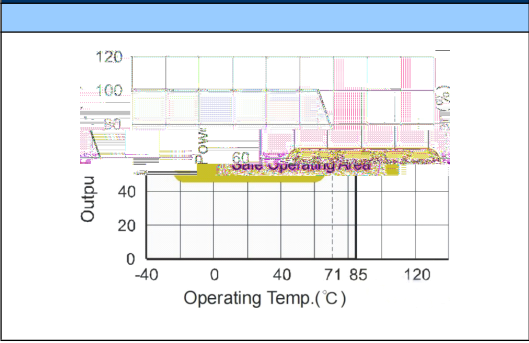

OPTIONAL DIODE PROTECTION CIRCUIT

Add a blocking diode to Vout if current can flow backwards into the output, as this can damage the converter when it is powered down.

The diode can either be fitted across the device if the source is low impedance or fitted in series with the output (recommended).

Optional Protection 1

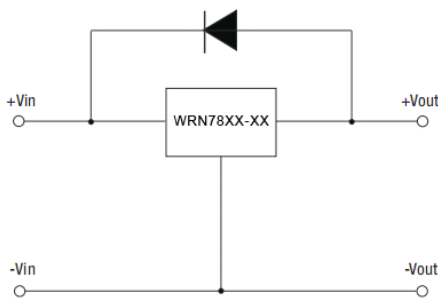

Optional Protection 2

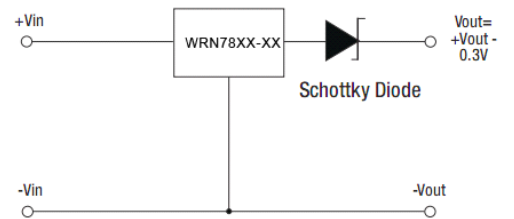

Application example:
Driving a high capacitive load

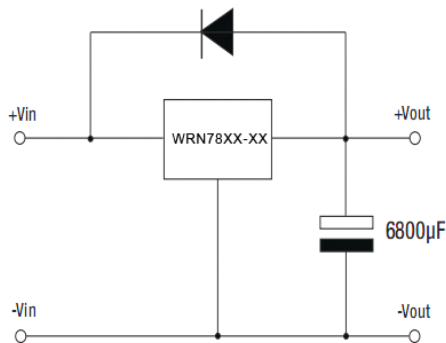

APPLICATION EXAMPLE

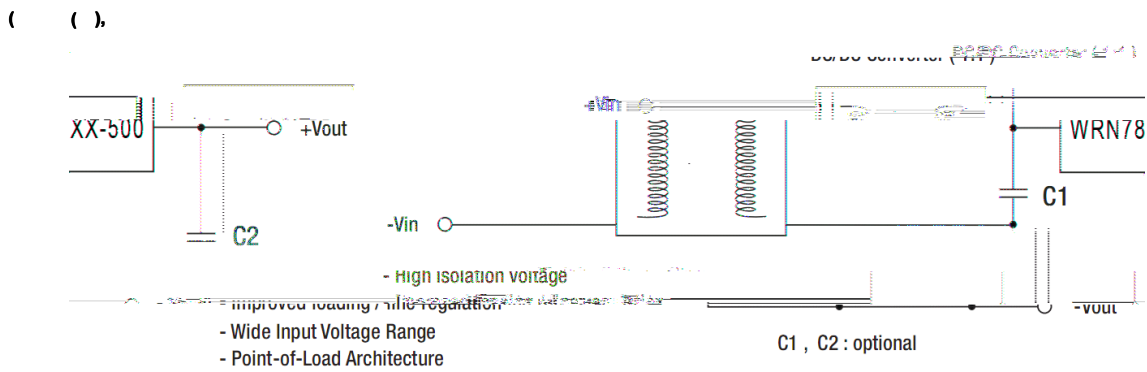
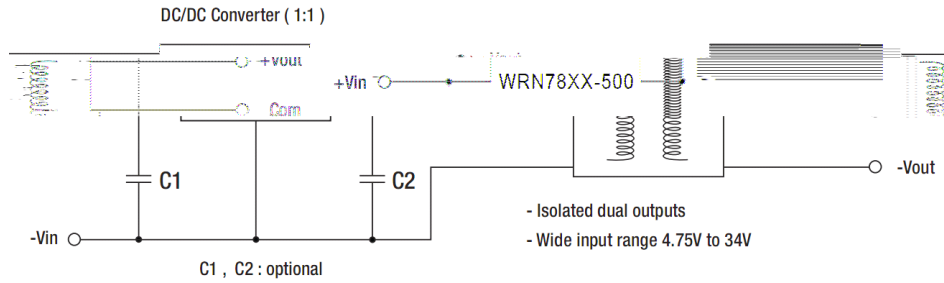

MECHANICAL DIMENSIONS

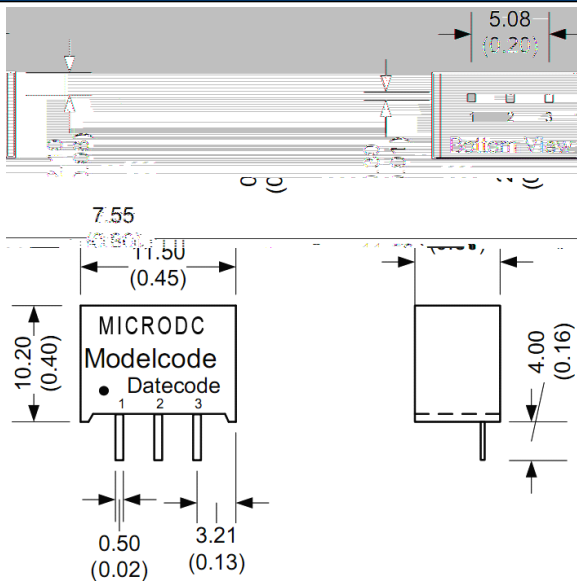

RECOMMENDED FOOTPRINT

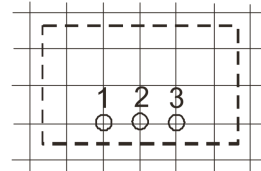

Pin	Connection
1	+ V Input
2	GND
3	+ V Output

TUBE OUTLINE DIMENSIONS

